

Potenciometry lineární, mono, 206 mm, 0,4W, 20-30%

Technické parametry	
Jmenovité zatížení při 40°C	0,4W
Rozsah hodnot	100 Ω až 4,7 MΩ
Pracovní napětí trvalé	500 VDC
Tolerance	±20% (R ≤ 1MΩ) ±30% (R > 1MΩ)
Řada	E3
Minimální odběr	10ks

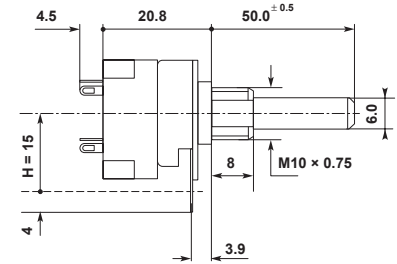
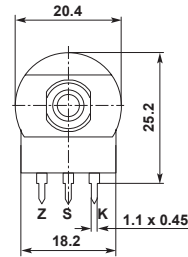

Obj.č	TYP	Cena	Popis
1502768	P20MLE100	23,09	100R
1502769	P20MLE220	23,09	220R
1502770	P20MLE470	23,09	470R
1502771	P20MLK001	23,09	1K
1502772	P20MLK002,2	23,09	2K2
1502773	P20MLK004,7	23,09	4K7
1502774	P20MLK010	23,09	10K
1502775	P20MLK022	23,09	22K
1502776	P20MLK047	23,09	47K
1502777	P20MLK100	23,09	100K

Obj.č	TYP	Cena	Popis
1502778	P20MLK220	23,09	220K
1502779	P20MLK470	23,09	470K
1502780	P20MLM001	23,09	1M0
1502781	P20MLM002,2	23,09	2M2
1502782	P20MLM004,7	23,09	4M7

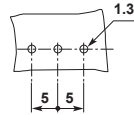

Potenciometry cermetové precizní

Potenciometry lineární, mono, 1W, 20%

Technické parametry	
Jmenovité zatížení při 40°C	1W
Rozsah hodnot	1 kΩ až 100 kΩ
Rozsah teplot	-55 až 125 °C
Pracovní napětí trvalé	350 VDC
Tolerance	±20%
Řada	1 - 4,7 - 10 ...
Minimální odběr	1ks

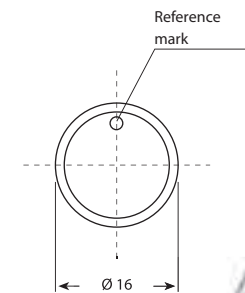
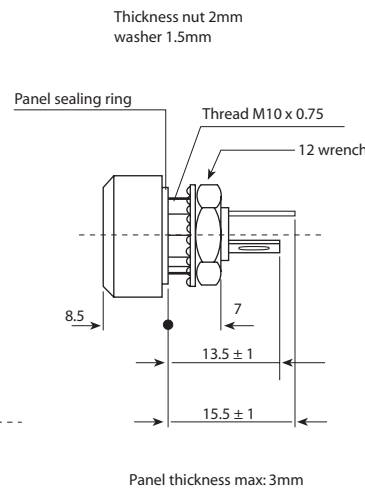

Obj.č	TYP	Cena	Popis
1521860	P16NPK001	192,42	1K
1521861	P16NPK004,7	192,42	4K7
1521862	P16NPK010	192,42	10K
1521863	P16NPK047	192,42	47K
1521864	P16NPK100	192,42	100K

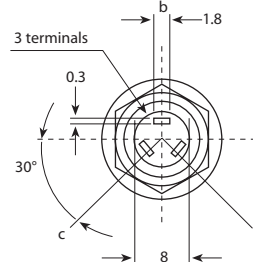

Potenciometry lineární, mono, 3W, 20%

Technické parametry	
Jmenovité zatížení při 70°C	3W
Rozsah hodnot	1 kΩ až 100 kΩ
Rozsah teplot	-55 až 155 °C
Teplotní koeficient	±100ppm/°C
Pracovní napětí trvalé	600 VDC
Tolerance	±20%
Řada	1 - 4,7 - 10 ...
Minimální odběr	1ks

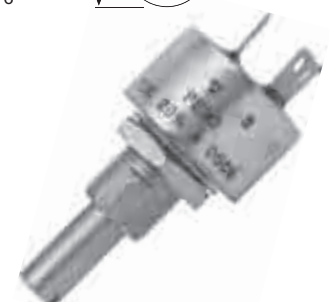
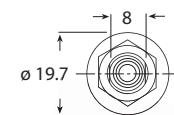
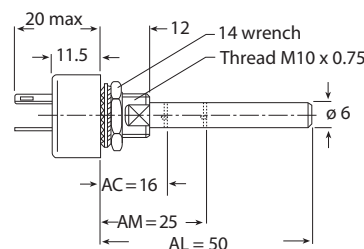

Obj.č	TYP	Cena	Popis
1514119	PE30K001	352,36	1K
1514120	PE30K004,7	352,36	4K7
1514121	PE30K010	352,36	10K

Obj.č	TYP	Cena	Popis
1514122	PE30K047	352,36	47K
1514123	PE30K100	352,36	100K